

INTEGRA & VERTICAL

Dajemo vam mogućnost izbora
PLOČASTI RADIJATORI

Integra je klasični pločasti radiator s profiliranom prednjom stranom. Iza prednje strane se nalaze integrirano tijelo ventila i cijevni sustav, što znači da cijevi nisu vidljive na bočnoj strani. Ovaj radiator je samostojeći. Kao što sugerira njihovo ime, modeli Vertical su okrenuti prema gore kako biste maksimalno iskoristili zidni prostor. Tanki i profinjeni, osiguravaju maksimalnu toplinu čak i u ograničenom prostoru. Profiliranu prednju stranu možete opremiti priborom kao što je su držači ručnika za maksimalnu praktičnost.



PRIMJENA

Kuhinja	● ● ● ● ●	Kupaonica	● ● ●
Hodnik	● ● ● ● ●	Dnevna soba	● ● ● ● ●
Spavaća soba	● ● ● ● ●		



VISINA
Integra: 300, 400, 450,
500, 600, 750, 900 mm

DULJINA
Integra: 450 - 3000 mm

TIP
INT 11, 21S, 22, 33

BOJE
RAL 9016 bijela. Druge
RAL boje su raspoložive
na zahtjev.

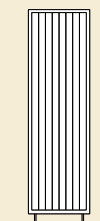

VISINA
Vertical: 1500, 1800,
1950, 2100, 2300 mm

DULJINA
Vertical: 450, 600,
750 mm

TIP
VR 10, 20, 21, 22

BOJE
RAL 9016 bijela. Druge
RAL boje su raspoložive
na zahtjev.

pločasti radijatori



Integra

Čista estetika: Spojna cijev je skrivena iza ploča. To znači da cijevi polaznog i povratnog voda možete sakriti u zidu. Lijepi bočni dio i završni premaz pružaju decentni izgled bez vidljivih cijevi.

- Pribor je uključen u pakovanje i cijenu:
1 slijepi završetak za ispust, 2 ili 3 držača Radsoclic (u funkciji duljine radijatora), vijci i zatici.
- Cjevovod za opskrbu toplom vodom je integriran na desnoj strani (lijevoj na zahtjev), a tijelo za podešavanje k_v -vrijednosti termostatskog ventila već je integrirano kao i rotirajući odzračni otvor, 2 slijepa završetka i zavarene viseće trake.
- Spojevi: 6 x Ø 1/2" (15/21).
- Boje: standardna boja RAL 9016.
Druge raspoložive boje: vidi str. 110.
- Pribor: vidi str. 104.



volumen : l/m

tip	300	400	450	500	600	750	900
11	1,80	2,42	2,73	3,04	3,67	4,60	5,53
21S	4,00	5,17	5,75	6,33	7,50	9,35	11,20
22	3,71	4,89	5,48	6,06	7,24	9,00	10,76
33	5,52	7,30	8,19	9,08	10,86	13,52	16,19

masa : kg/m

tip	300	400	450	500	600	750	900
11	9,60	12,82	14,43	16,04	19,27	24,10	28,93
21S	15,60	21,17	23,95	26,73	32,30	39,45	46,60
22	17,90	23,78	26,71	29,65	35,52	44,33	53,14
33	26,67	35,84	40,43	45,02	54,19	67,95	81,71

instalacija

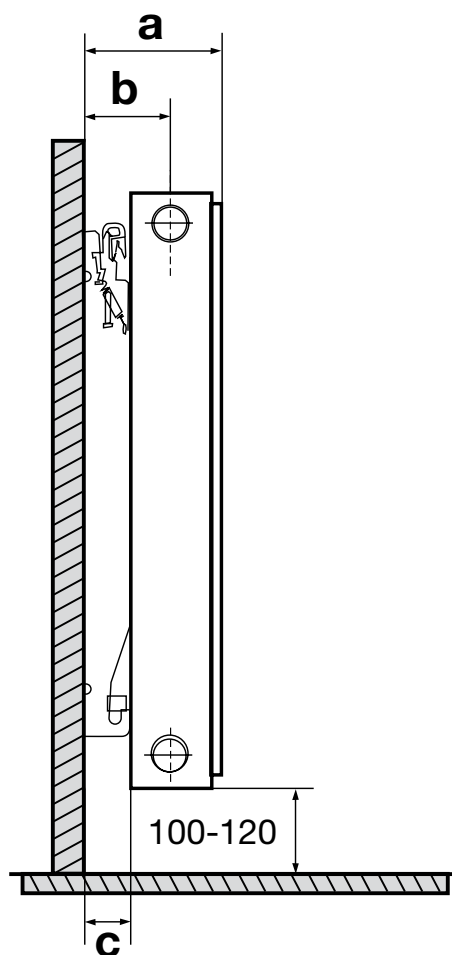

držač Radsoclic

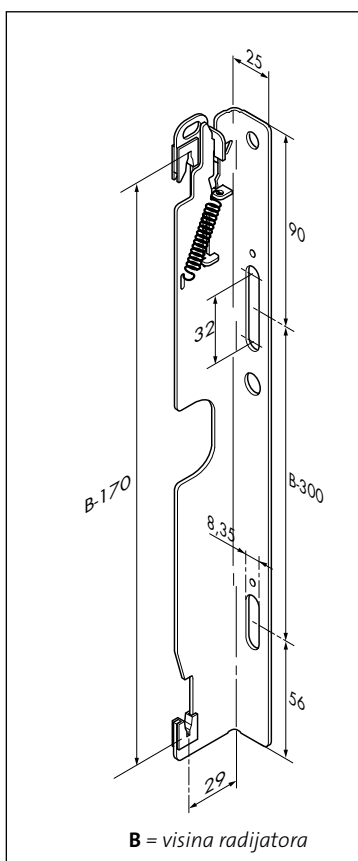

tip 11

a : 95 mm
b : 62 mm
c : 37 mm

tip 21s

a : 106 mm
b : 71 mm
c : 37 mm

tip 22

a : 142 mm
b : 89 mm
c : 37 mm

tip 33

a : 208 mm
b : 89 mm
c : 37 mm

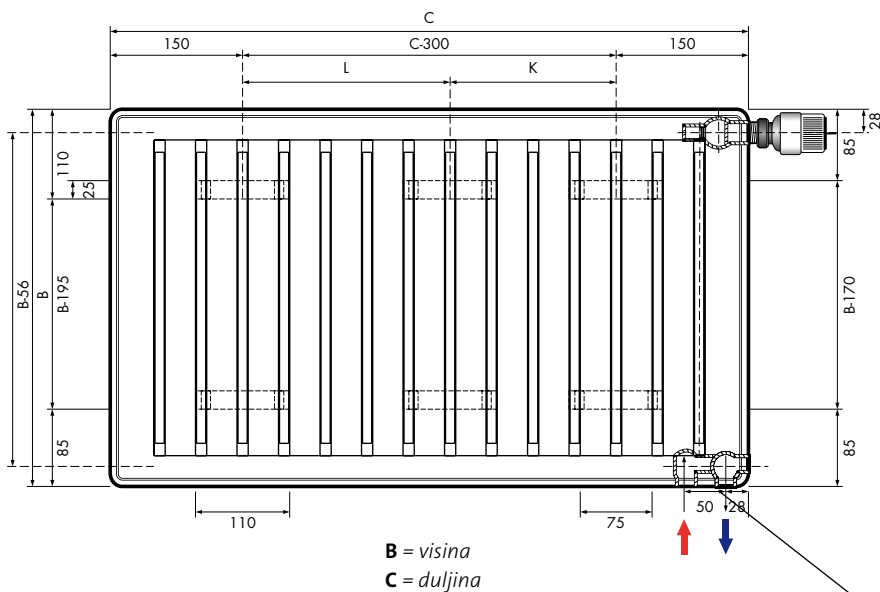

mjere traka za ovješnje		
duljina	K	L
1650	700	650
1800	750	750
1950	850	800
2100	900	900
2250	1000	950
2400	1050	1050
2550	1150	1100
2700	1200	1200
3000	1400	1350

Tip 11: radijatori duljine 1650 mm i dulji: 6 traka za ovješnje.
Tip 21S, 22 i 33: radijatori duljine 1650, 1800 i 1950 mm imaju samo 4 trake za ovješnje.
2100 mm i dulji: 6 traka za ovješnje.

spojevi

Mogućnosti spajanja s termostatskim ventilom.

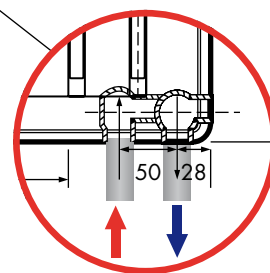

- ++ odlično
- + vrlo dobro
- + - dobro
- normalno

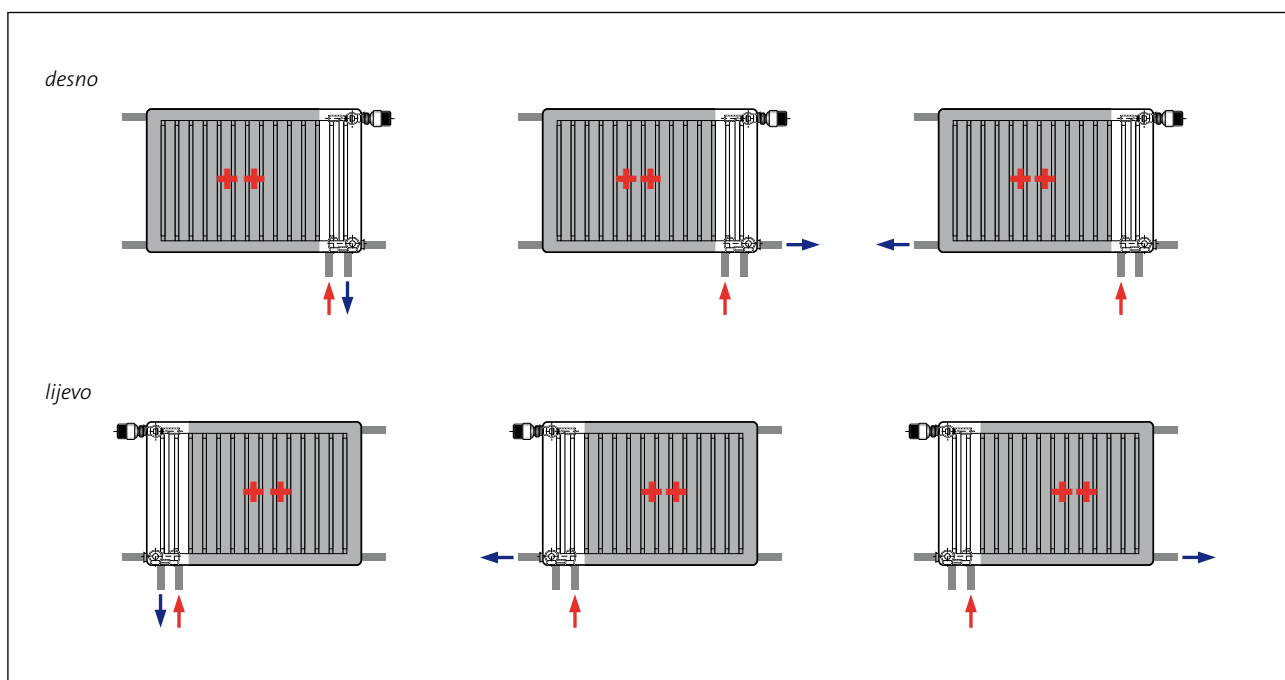
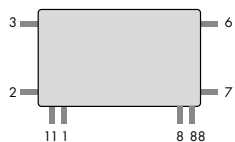

spojevi

Mogućnosti spajanja BEZ termostatskog ventila.

Svaki radijator Integra možete spojiti bez termostatskog ventila kao radijator 'Compact'.

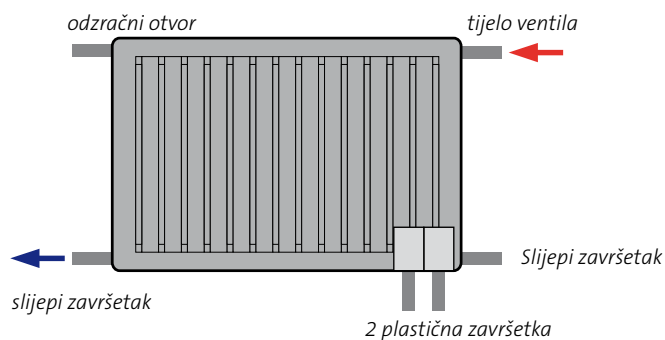

1. Uklonite tijelo ventila.
2. Uklonite 2 bočna slijepa završetka i pričvrstite ih na donje spojeve umjesto plastičnih završetaka.
3. Pričvrstite isporučeni slijepi završetak za ispušni na drugu stranu spoja.
4. Ako se spoj nalazi tamo gdje je bio odračni otvor, promijenite stranu odračnog otvora.

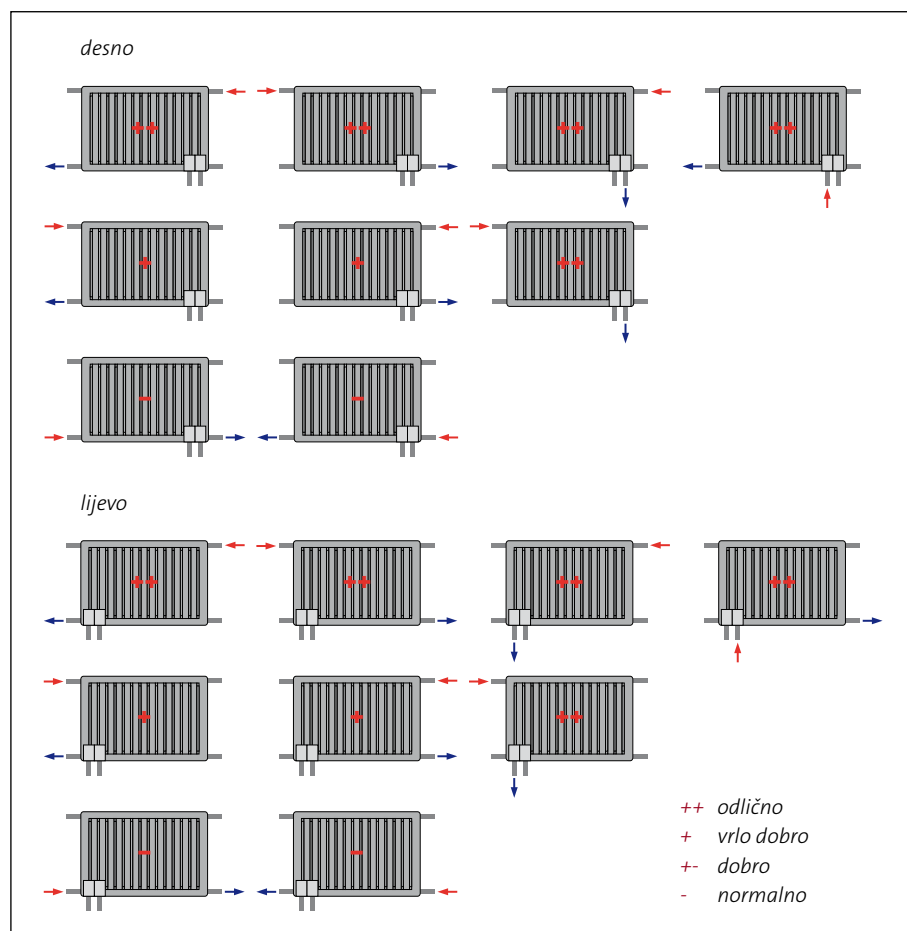



ŠIFRA ZA NARUDŽBU : **INT11XXXXYYZZ**
 PRIMJER : INT116001200L

radijator _____
 tip _____
 visina _____
 duljina _____

Z = L: lijevi spoj • R: desni spoj.

duljina	W + cijena	visina						
		300	400	450	500	600	750	900
450	75/65/20°C	248	318	351	384	446	534	616
	90/70/20°C	317	406	448	490	570	680	783
600	75/65/20°C	331	424	468	512	595	712	821
	90/70/20°C	423	541	598	653	760	907	1045
750	75/65/20°C	413	530	585	640	744	890	1026
	90/70/20°C	529	677	747	817	950	1134	1306
900	75/65/20°C	496	635	702	768	893	1068	1231
	90/70/20°C	635	812	896	980	1139	1361	1567
1050	75/65/20°C	579	741	819	896	1042	1246	1436
	90/70/20°C	740	947	1046	1143	1329	1588	1828
1200	75/65/20°C	661	847	936	1024	1190	1424	1642
	90/70/20°C	846	1082	1195	1307	1519	1814	2089
1350	75/65/20°C	744	953	1053	1152	1339	1602	1847
	90/70/20°C	952	1218	1345	1470	1709	2041	2350
1500	75/65/20°C	827	1059	1170	1280	1488	1781	2052
	90/70/20°C	1058	1353	1494	1634	1899	2268	2612
1650	75/65/20°C	909	1165	1287	1407	1637	1959	2257
	90/70/20°C	1163	1488	1643	1797	2089	2495	2873
1800	75/65/20°C	992	1271	1404	1535	1786	2137	2462
	90/70/20°C	1269	1624	1793	1960	2279	2722	3134

u skladu s EN 442 – 75/65/20 °C (ΔT50)

W/m 90/70/20 °C vrijednost n	705	902	996	1089	1266	1512	1741
	1,3498	1,3451	1,3427	1,3404	1,3357	1,3287	1,3217

bez dodatnog troška za lijevo spajanje

isporuka odmah

isporuka odmah

ŠIFRA ZA NARUDŽBU : INT21XXXXYYZZ

PRIMJER : INT216001200L

radijator

tip

visina

duljina

Z = L: lijevi spoj • R: desni spoj



duljina	W + cijena	visina						
		300	400	450	500	600	750	900
450	75/65/20°C	361	448	490	530	607	718	823
	90/70/20°C	463	575	627	678	777	917	1050
600	75/65/20°C	481	598	653	706	809	957	1097
	90/70/20°C	617	766	836	904	1036	1223	1400
750	75/65/20°C	602	747	816	883	1012	1196	1372
	90/70/20°C	772	958	1046	1130	1295	1529	1751
900	75/65/20°C	722	896	979	1059	1214	1436	1646
	90/70/20°C	926	1149	1255	1356	1553	1834	2101
1050	75/65/20°C	842	1046	1142	1236	1416	1675	1920
	90/70/20°C	1080	1341	1464	1582	1812	2140	2451
1200	75/65/20°C	962	1195	1306	1412	1619	1914	2195
	90/70/20°C	1235	1532	1673	1808	2071	2446	2801
1350	75/65/20°C	1083	1345	1469	1589	1821	2153	2469
	90/70/20°C	1389	1724	1882	2034	2330	2751	3151
1500	75/65/20°C	1203	1494	1632	1766	2024	2393	2744
	90/70/20°C	1544	1916	2091	2261	2589	3057	3501
1650	75/65/20°C	1323	1643	1795	1942	2226	2632	3018
	90/70/20°C	1698	2107	2300	2487	2848	3363	3851
1800	75/65/20°C	1444	1793	1958	2119	2428	2871	3292
	90/70/20°C	1852	2299	2509	2713	3107	3668	4201
1950	75/65/20°C	1564	1942	2122	2295	2631	3110	3567
	90/70/20°C	2007	2490	2718	2939	3366	3974	4551
2100	75/65/20°C	1684	2092	2285	2472	2833	3350	3841
	90/70/20°C	2161	2682	2927	3165	3625	4280	4901
2250	75/65/20°C	1805	2241	2448	2648	3035	3589	4115
	90/70/20°C	2315	2873	3137	3391	3884	4586	5252
2400	75/65/20°C	1925	2390	2611	2825	3238	3828	4390
	90/70/20°C	2470	3065	3346	3617	4142	4891	5602
2550	75/65/20°C	2045	2540	2774	3001	3440	4067	4664
	90/70/20°C	2624	3256	3555	3843	4401	5197	5952
2700	75/65/20°C	2165	2689	2938	3178	3642	4307	4938
	90/70/20°C	2778	3448	3764	4069	4660	5503	6302
3000	75/65/20°C	2406	2988	3264	3531	4047	4785	5487
	90/70/20°C	3087	3831	4182	4521	5178	6114	7002

u skladu s EN 442 – 75/65/20 °C (ΔT50)

W/m 90/70/20 °C vrijednost n	1029	1277	1394	1507	1726	2038	2334
	1,3668	1,3620	1,3596	1,3572	1,3523	1,3451	1,3379

bez dodatnog troška za lijevo spajanje

isporuka odmah

isporuka odmah

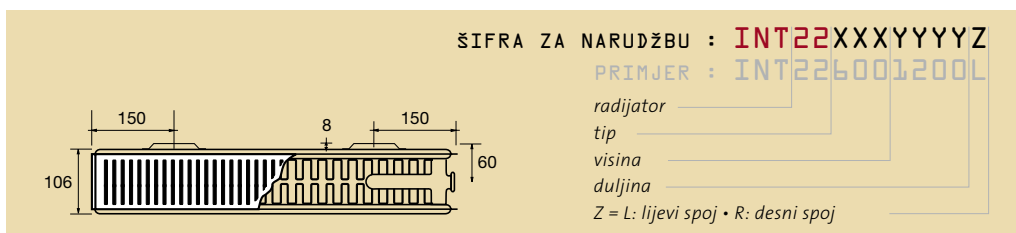

duljina	W + cijena	visina						
		300	400	450	500	600	750	900
450	75/65/20°C	474	601	661	718	824	968	1092
	90/70/20°C	610	773	848	921	1056	1236	1392
600	75/65/20°C	632	802	881	957	1099	1290	1456
	90/70/20°C	813	1030	1131	1228	1408	1648	1856
750	75/65/20°C	790	1002	1101	1196	1374	1613	1820
	90/70/20°C	1016	1288	1414	1535	1760	2060	2321
900	75/65/20°C	948	1202	1321	1436	1649	1935	2184
	90/70/20°C	1220	1545	1697	1841	2112	2472	2785
1050	75/65/20°C	1106	1403	1541	1675	1924	2258	2548
	90/70/20°C	1423	1803	1979	2148	2464	2884	3249
1200	75/65/20°C	1264	1603	1762	1914	2198	2580	2912
	90/70/20°C	1626	2060	2262	2455	2816	3296	3713
1350	75/65/20°C	1422	1804	1982	2153	2473	2903	3276
	90/70/20°C	1829	2318	2545	2762	3168	3708	4177
1500	75/65/20°C	1580	2004	2202	2393	2748	3225	3641
	90/70/20°C	2033	2576	2828	3069	3521	4121	4641
1650	75/65/20°C	1737	2204	2422	2632	3023	3548	4005
	90/70/20°C	2236	2833	3110	3376	3873	4533	5105
1800	75/65/20°C	1895	2405	2642	2871	3298	3870	4369
	90/70/20°C	2439	3091	3393	3683	4225	4945	5569
1950	75/65/20°C	2053	2605	2863	3110	3572	4193	4733
	90/70/20°C	2642	3348	3676	3990	4577	5357	6033
2100	75/65/20°C	2211	2806	3083	3350	3847	4515	5097
	90/70/20°C	2846	3606	3959	4297	4929	5769	6497
2250	75/65/20°C	2369	3006	3303	3589	4122	4838	5461
	90/70/20°C	3049	3863	4241	4604	5281	6181	6962
2400	75/65/20°C	2527	3206	3523	3828	4397	5160	5825
	90/70/20°C	3252	4121	4524	4910	5633	6593	7426
2550	75/65/20°C	2685	3407	3743	4067	4672	5483	6189
	90/70/20°C	3455	4378	4807	5217	5985	7005	7890
2700	75/65/20°C	2843	3607	3964	4307	4946	5805	6553
	90/70/20°C	3659	4636	5090	5524	6337	7417	8354
3000	75/65/20°C	3159	4008	4404	4785	5496	6451	7281
	90/70/20°C	4065	5151	5655	6138	7041	8241	9282

u skladu s EN 442 – 75/65/20 °C (ΔT50)

W/m 90/70/20 °C vrijednost n	1355	1717	1885	2046	2347	2747	3094
	1,3845	1,3757	1,3713	1,3669	1,3581	1,3449	1,3316

bez dodatnog troška za lijevo spajanje

isporuka odmah

isporuka odmah

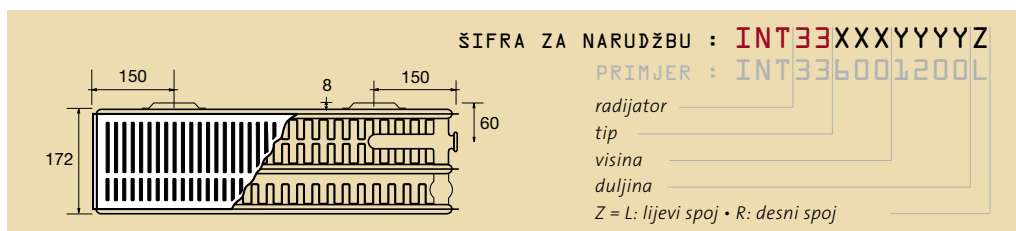

duljina	W + cijena	visina						
		300	400	450	500	600	750	900
450	75/65/20°C	672	863	952	1037	1195	1404	1580
	90/70/20°C	864	1107	1220	1328	1526	1787	2005
600	75/65/20°C	896	1151	1270	1383	1594	1871	2107
	90/70/20°C	1152	1476	1627	1770	2035	2382	2674
750	75/65/20°C	1121	1439	1587	1729	1992	2339	2634
	90/70/20°C	1440	1845	2033	2213	2544	2978	3342
900	75/65/20°C	1345	1726	1904	2075	2390	2807	3161
	90/70/20°C	1728	2214	2440	2655	3053	3573	4010
1050	75/65/20°C	1569	2014	2222	2420	2789	3275	3688
	90/70/20°C	2016	2583	2847	3098	3562	4169	4679
1200	75/65/20°C	1793	2302	2539	2766	3187	3743	4214
	90/70/20°C	2304	2952	3253	3540	4070	4764	5347
1350	75/65/20°C	2017	2589	2857	3112	3586	4211	4741
	90/70/20°C	2592	3321	3660	3983	4579	5360	6016
1500	75/65/20°C	2241	2877	3174	3458	3984	4679	5268
	90/70/20°C	2880	3690	4067	4425	5088	5955	6684
1650	75/65/20°C	2465	3165	3491	3803	4382	5146	5795
	90/70/20°C	3168	4059	4473	4868	5597	6551	7352
1800	75/65/20°C	2689	3452	3809	4149	4781	5614	6322
	90/70/20°C	3456	4428	4880	5310	6106	7146	8021
1950	75/65/20°C	2913	3740	4126	4495	5179	6082	6848
	90/70/20°C	3744	4797	5286	5753	6614	7742	8689
2100	75/65/20°C	3137	4028	4444	4841	5578	6550	7375
	90/70/20°C	4032	5166	5693	6195	7123	8337	9358
2250	75/65/20°C	3362	4316	4761	5186	5976	7018	7902
	90/70/20°C	4320	5535	6100	6638	7632	8933	10026
2400	75/65/20°C	3586	4603	5078	5532	6374	7486	8429
	90/70/20°C	4608	5904	6506	7080	8141	9528	10694
2550	75/65/20°C	3810	4891	5396	5878	6773	7953	8956
	90/70/20°C	4896	6273	6913	7523	8650	10124	11363
2700	75/65/20°C	4034	5179	5713	6224	7171	8421	9482
	90/70/20°C	5184	6642	7320	7965	9158	10719	12031
3000	75/65/20°C	4482	5754	6348	6915	7968	9357	10536
	90/70/20°C	5760	7380	8133	8850	10176	11910	13368

u skladu s EN 442 – 75/65/20 °C (ΔT50)

W/m 90/70/20 °C vrijednost n	1920	2460	2711	2950	3392	3970	4456
	1,3768	1,3651	1,3592	1,3533	1,3415	1,3238	1,3061

bez dodatnog troška za lijevo spajanje

isporuka odmah isporuka odmah